

# MONTICELLO

How to build the paper model featured in the book *American Landmarks: Miniature Models to Cut and Assemble* by Matt Bergstrom (©2012 Dover Publications, Inc.)

**1**

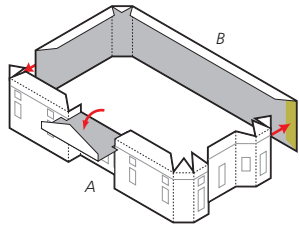

Cut out wall pieces A & B. Note that the roof of the front porch and the inside of the side portico on piece A are reverse (valley) folds.

Fold the corners of the house at 45-degree angles and attach the two pieces together. Fold the front porch roof down.

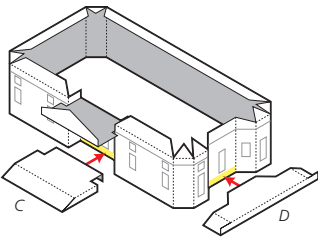

Cut out and fold the front porch C and floor of the side portico D. Glue C and D in place against the house. If the porch does not sit flat against the ground, place a small weight on top while the glue dries.

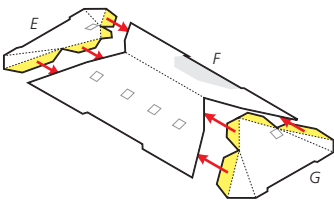

Cut out roof pieces E, F & G. Score the fold lines of the rooftop. Glue the tabs of the side roofs under the center section. Use the diagram to match up the correct roof piece to each end of the center section.

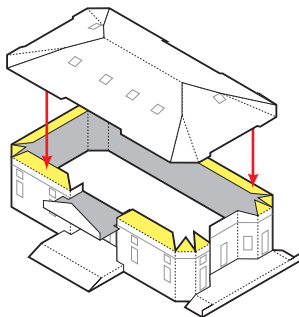

Glue the rooftop to the house walls. Place the side of the rooftop with the four skylights at the front of the house, as shown in the diagram. Flip the model over to make sure the roof is centered on the house and that the eaves overhang the walls evenly on each side.

**2**

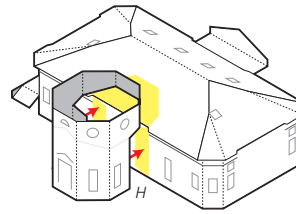

Cut the rotunda H. Fold and assemble into an octagonal shape. Check the fit of the piece against the house and trim the edge of the roof if necessary. Glue the rotunda to the wall and roof of the house.

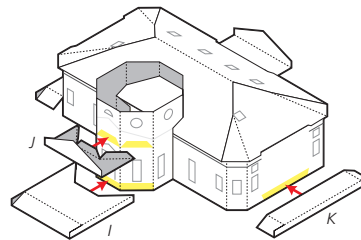

Cut out the rear porch pieces I and J. Fold the small tabs with a tweezer to get a crisp fold and make sure the pieces fit snugly against the walls of the rotunda.

Cut out the floor of the side portico K and glue in place against the house. If the porch does not sit flat against the ground, place a small weight on top while the glue dries.

**3**

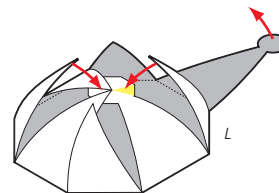

Cut out the dome L. Score the dotted line around the dome and curl the triangular sections against a round pencil or dowel.

Fold down the triangular section with the octagonal tab at the end. Then fold down the opposite section and glue the tip of the triangle at the center of the octagonal tab. Use a tweezer to position the tabs correctly.

Let the glue dry, then fold the next section down and glue the tip to the octagonal tab. The edges of the sections should match to form a shallow dome. Lastly, fold down the section with the round tab at the end to cover the center of the dome where all the triangles meet together.

See other paper model kits in the book *American Landmarks: Miniature Models to Cut and Assemble*

ISBN 978-0486482811

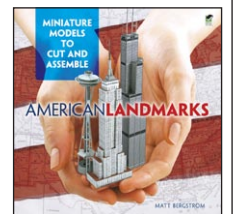

# MONTICELLO

How to build the paper model featured in the book *American Landmarks: Miniature Models to Cut and Assemble* by Matt Bergstrom (©2012 Dover Publications, Inc.)

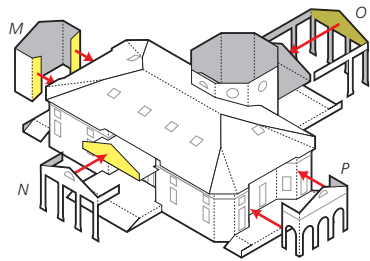

4

Cut out porticoes M, N, O & P. Glue the triangular tops of the front and back porches against the triangular pieces of the house, the pillars to the porch floor and the sides to match the wood trim on the walls.

Glue the side porticoes against the walls of the house and portico floors.

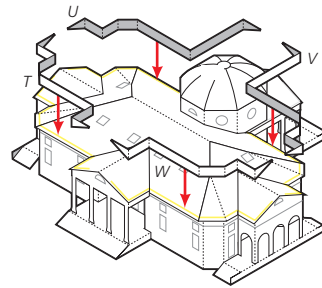

5

Cut out the rooftop railings T, U, V & W. Note that some of the folds are reverse (valley) folds and others are forward (mountain) folds to match the contours of the rooftop. Use a tweezers to carefully glue the railings in place.

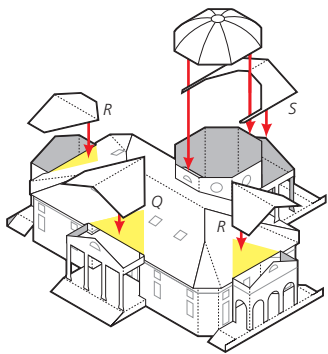

Cut out side roofs Q, R & S. Glue in place against the rooftop and tops of the triangular porches and porticoes.

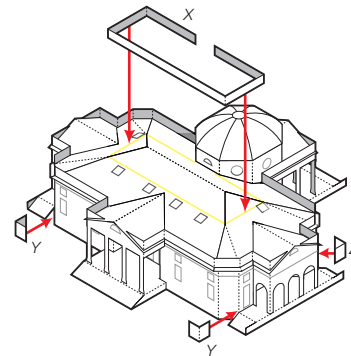

Cut out the rectangular railing X and glue in place on the rooftop.

Cut out the tiny railings Y and brick corners Z and glue to the corners of the house.

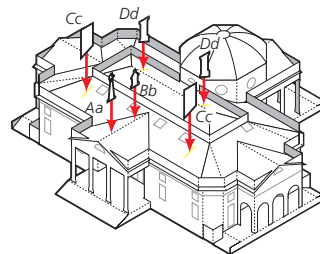

Finally, cut out the weather vane Aa, cupola Bb and chimneys Cc and Dd. Glue each piece back-to-back and then glue upright in place on the rooftop.

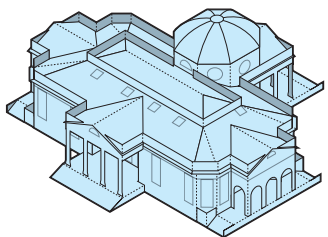

Now your paper model of Monticello is finished!

See other paper model kits in the book *American Landmarks: Miniature Models to Cut and Assemble*

ISBN 978-0486482811

